

MINI CLEANER

PVC Rohr

S
T
A
N
D
A
R
D

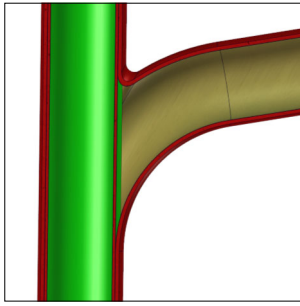

NICHT GELINERTE



Twister Mini Flexi Express

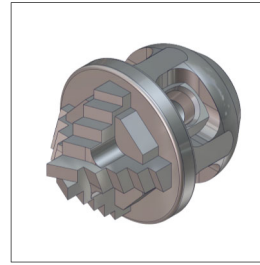

Frontbohrkopf (PVC)

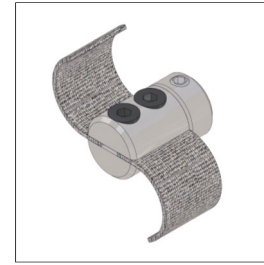

Smart Cutter™

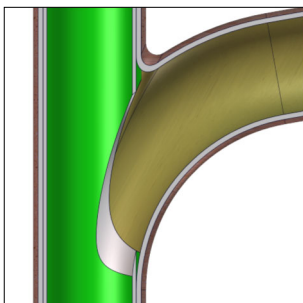

GEÖFFNET



Smart Cutter™



Twister Mini Flexi Express

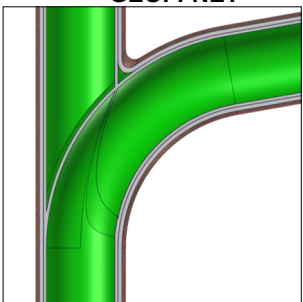

GELINERTE

Mini Cleaner

Wellendurchmesser: **8 mm**

Länge: **16 m**

Empfohlene Rohrgröße : **DN32 - DN75**

Bei PVC Rohr, Smart Cutter™ sollte mit Polierpapieren ausgestattet sein

B
E
S
O
N
D
E
R
E

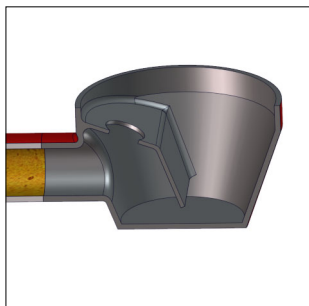

BODENABLAUF

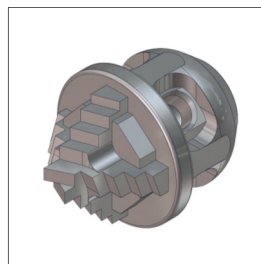

Frontbohrkopf (PVC)



Smart Cutter™

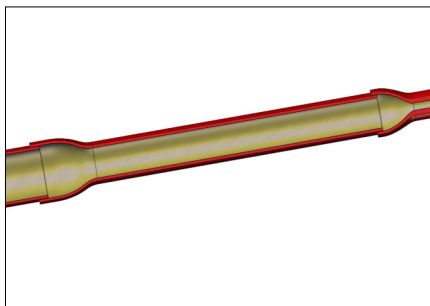

Durchmesseränderungen

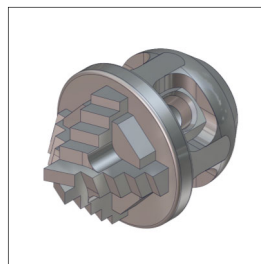

Frontbohrkopf (PVC)



Smart Cutter™

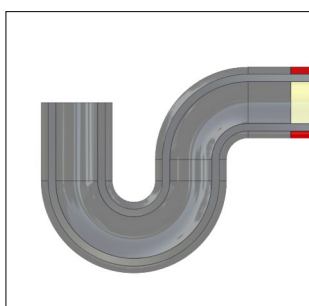

P-TRAP

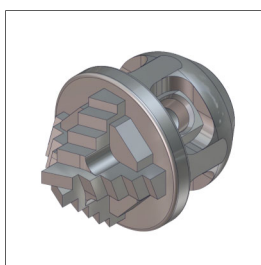

Frontbohrkopf (PVC)



Smart Cutter™



Twister Mini Flexi Express

Die optimale Drehzeit des Mini Cleaner liegt je nach Arbeit zwischen 2-4 (900-2100 U/min).

Verwenden Sie keine höhere Drehzahl als 4 (2100 U/min), da dies zu einer Überhitzung zwischen der Welle und dem Außengehäuse führen kann

Verfügbare Werkzeuge

Größe Durchmesser

Smart Cutter™

DN32 - DN75

Twister Mini Flexi Express

DN50 - DN75

Frontbohrkopf (PVC)

DN32 - DN75